

Start Here



1. Activating the SiriusXM Music for Business Internet Service

Instructions to retrieve your credentials were sent to the Shop Beats Contact Email.

If you need a reset them, go to siriusxm.com/player or **download the SiriusXM App** and click “Forgot Username or Password.” Should you need help with this process, please contact: **800-852-9696**.

2. Connect the Radio

These instructions are for a wired connection to the Internet. **Sirius XM strongly recommends a wired internet connection for all business installations.** An Ethernet cable is included. The network must be connected to the Internet.

- Connect the Ethernet cable to the **LAN** connector of the Radio. Connect the other end to your local network.
- Connect the Power Adapter to the **DC 12V** connector, and plug the Power Adapter to an AC outlet. The Radio will power on automatically.
- If the Radio has successfully connected to the network, the Ethernet icon in the upper left corner will be displayed without a red **X** (Figure 1). If there is no network connectivity, the Ethernet icon will be displayed with a red **X** (Figure 2). Check the Ethernet cable connection. If necessary, refer to the User Guide for more detailed network setup information.
- Connect the Radio to a stereo system using the provided Stereo Audio Cable, and turn the stereo system on.



Figure 1



Figure 2

3. Enter Your SiriusXM Credentials

- Turn the **Scroll knob** to highlight **Setup** and press the **Scroll knob** to select. **SiriusXM Account** will be highlighted, press **Scroll knob** to select.
- Username** will be highlighted. Press the **Scroll knob**. Enter each character in your SiriusXM streaming username and press the **Scroll knob** to select the character (Figure 3). When complete press the **SHIFT** button. Your username is case sensitive.
- Turn the **Scroll knob** to highlight **Password** and press the **Scroll knob** to select. Enter each character in your password and press the **Scroll knob** to select the character. When complete press the **SHIFT** button. Your password is case sensitive.
- The Sound Station will connect to SiriusXM and confirm the username and password you entered. If correct, “Credentials Accepted” will be briefly displayed.
- Next you will be prompted to select your time zone. Turn the **Scroll knob** to highlight your time zone and press the **Scroll knob** to select.
- If you are prompted that an Internet Update is available, allow the update to install. Turn the **Scroll knob** to highlight **Install Update** and press the **Scroll knob** to select. Wait until the update has completed and you see the message, “Please press the Power button”.

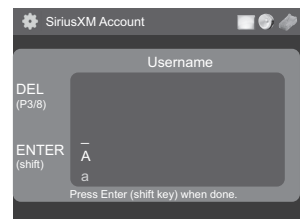

Figure 3

4. Selecting a Channel

The first time the Radio successfully connects to the SiriusXM Music for Business Internet Service, no channel will have been selected to play. Select a channel:

- If you are not at the Home screen, press **BACK** until the Home screen is displayed.
- Highlight **Categories** and press the **Scroll knob**. The category list will be displayed (Figure 4).
- You can select **All Channels** to browse through every available channel, or narrow the category list of channels by selecting **Pop**, **Rock**, **Hip-Hop**, etc. Turn the **Scroll knob** to highlight your selection and press the **Scroll knob**.
- Use the **BACK** button to return to the previous screen as you search for a channel.
- Once you have located the channel you want to tune, highlight the channel and press the **Scroll knob**. When the Radio connects to the channel, the audio will begin playing and the Now Playing screen will be displayed.

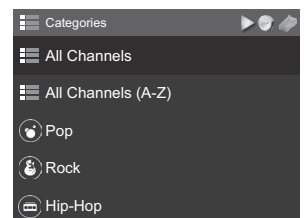
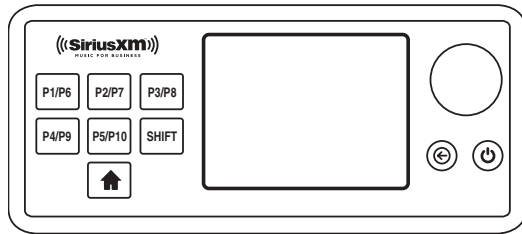

Figure 4

SiriusXM Music For Business Internet Radio Quick Start Guide

What's in the Box?



SiriusXM Business Radio

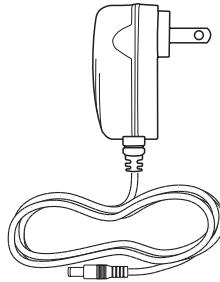

Power Adapter



Ethernet Cable

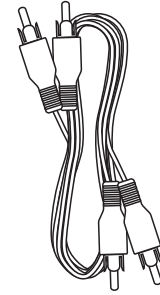

Stereo Audio Cable



Mono Audio Cable

Button Functions and Connectors

- Channel Presets P1 - P10:** Press and hold to save channels as presets; press to select presets. Press **SHIFT** button then preset button to access presets 6-10.
- Home Button:** Press once to return to the Home screen, or press twice to return to the Now Playing screen.
- Display Screen:** LCD display screen.
- Back Button:** Press to return to the previous screen.
- Power Button:** Press to turn the Radio on or off.
- Scroll knob:** Turn to scroll through lists or icons. Press to select a highlighted item or icon. At the Now Playing screen, press and hold to enter a channel number and tune the channel.
- AUX In:** Used to connect an alternate audio source to the Radio.
- Stereo Out L/R:** Used to connect the Radio to a stereo audio system.
- Mono Out:** Used to connect the Radio to a phone system.
- LAN:** Connector for a wired Ethernet connection.
- DC 12V:** Power connector for the supplied Power Adapter. (12 volts)

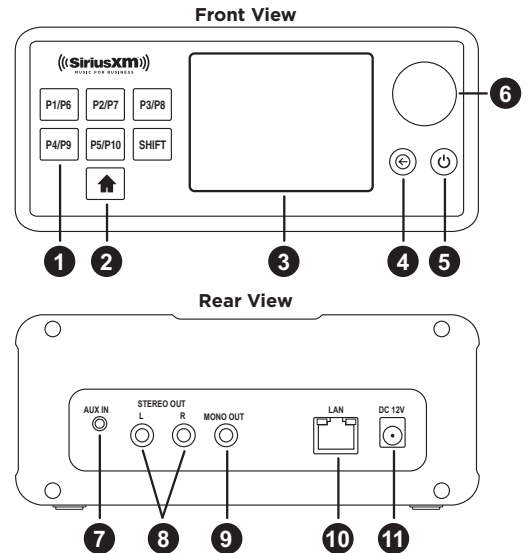

Home and Now Playing Screens

Home Screen

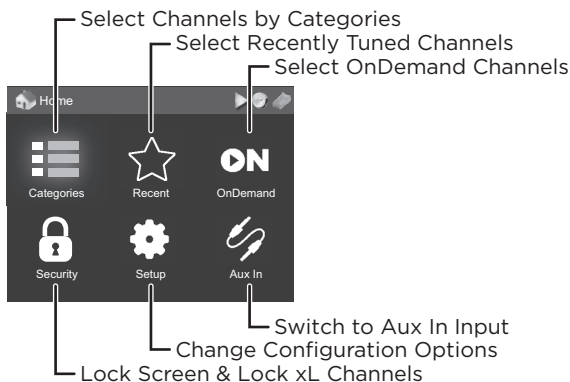

Now Playing Screen

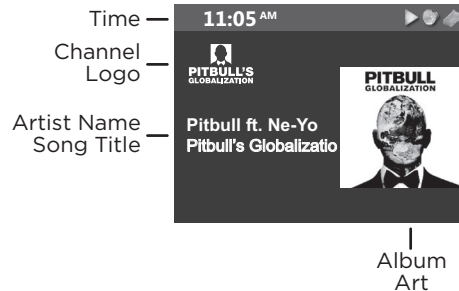

Self installation instructions and tips are provided for your convenience. It is your responsibility to determine if you have the knowledge, skills and physical ability required to properly perform an installation. SiriusXM shall have no liability for damage or injury resulting from the installation or use of any SiriusXM or third party products. It is your responsibility to ensure that all products are installed in adherence with local laws and regulations. SiriusXM product warranties do not cover the installation, removal or reinstallation of any product.

IMPORTANT NOTICE: REQUIRED SUBSCRIPTION

Hardware and subscription sold separately, and activation fee required. Other fees and taxes may apply. **Your subscription is governed by our Customer Agreement which you will find at http://www.siriusxm.com/pdf/siriusmbiz_customeragreement_eng.pdf.** Prices and programming are subject to change. **Service automatically renews into the subscription Package you choose, for additional periods of the same length, and automatically bills at the then current rates, after any complimentary trial or promotional period ends, until you call us at 1-866-345-7474 to cancel.** Our satellite service is available only to those at least 18 and older in the 48 contiguous USA and D.C. Our Sirius satellite service is also available in PR (with coverage limitations). Our Internet radio service is available throughout our satellite service area and in AK and HI.

Sirius XM Radio Inc, 1290 Avenue of the Americas, New York, NY 10104 1.866.345.7474